

 Aluminum stand with 2 pcs. 25 mm alu snap-frames. For indoor use.

 Aluminium Ständer, einseitig, mit 2 Stück 25 mm Alu Snap-Frames. Für den Innenbereich.

 Aluminium stander monteret med 2 stk. 25 mm alu snap-frames. Til indendørs brug.

FOR INDOOR USE!

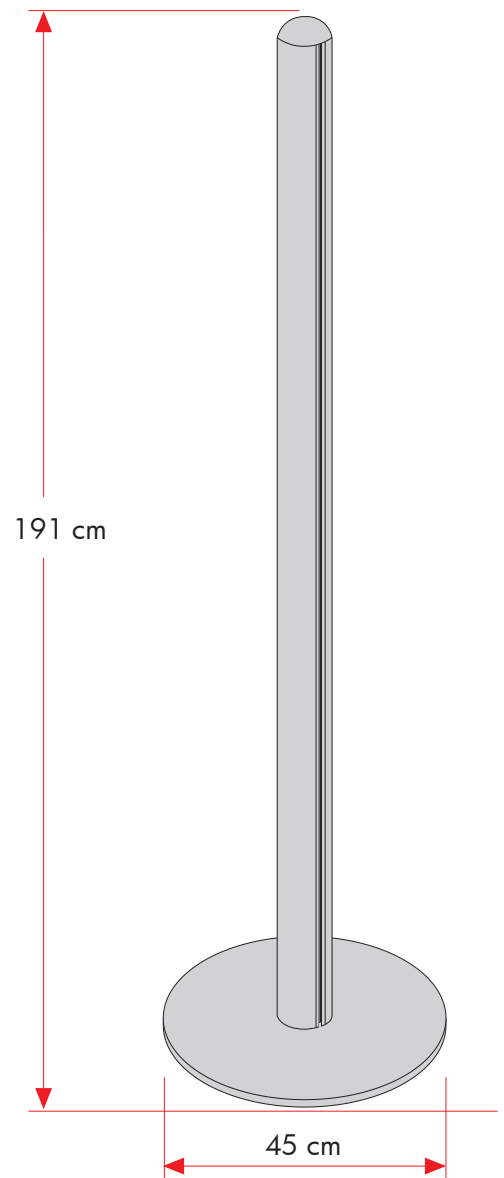
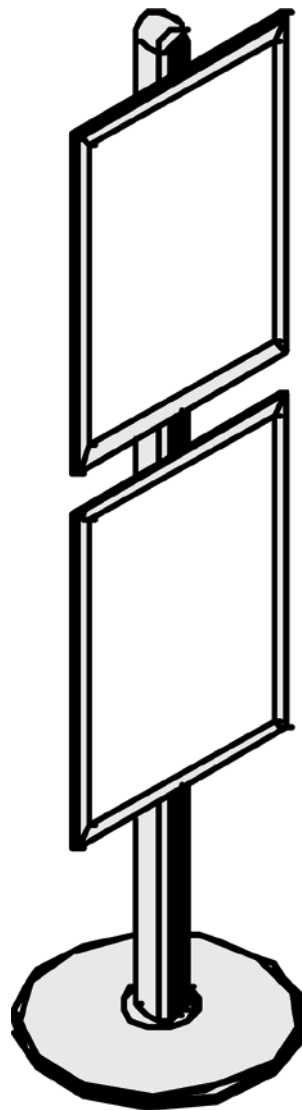

OPTIONAL
ROUND SHELF:
MODEL 968/ART. 2885



OPTIONAL
iPAD HOLDER
MODEL 969/ART. 2879

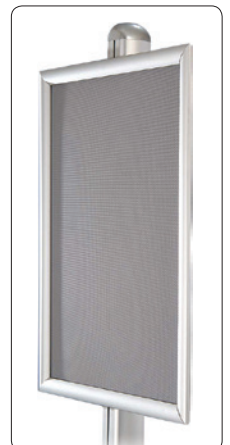
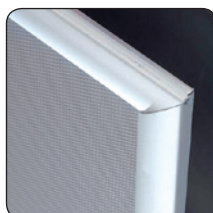

Model	Art. no.	Poster size	Colour	Total W x H	Base	Package size and weight	Pallet size and quantity
911	2996	50 x 70 cm	Alu	52,9 x 190 cm	Ø 45 cm	8x195x9 + 47x47x5 + 56x76x12 cm 16,0 kg	80 x 120 x 220 cm 30 pcs.
-	2997	60 x 85 cm	-	62,3 x 190 cm	-	8x195x9 + 47x47x5 + 66x91x12 cm 18,5 kg	80 x 120 x 220 cm 30 pcs.

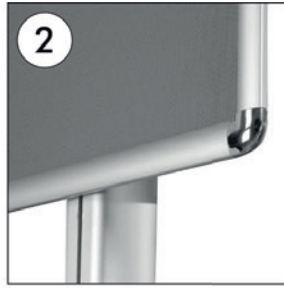
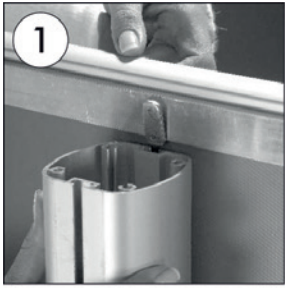

- Slide the back connectors of the frame through the channel of the pole.
- Schieben Sie die Mutter an der Rückseite des Rahmens in den Kanal am Mastprofil bis auf die gewünschte Stelle hinein.

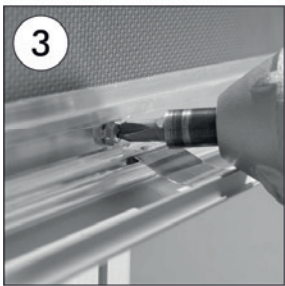

- Fix the frame in the desired height.
- Befestigen Sie den Rahmen durch Festziehen der Schrauben in der Innenseite.

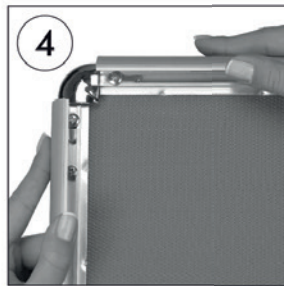

- Open all profiles.
- Alle Profile in der Pfeilrichtung öffnen.

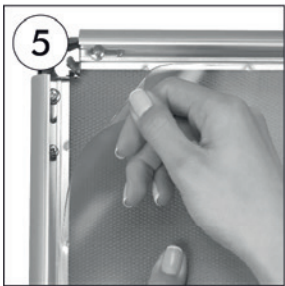

- Take-off the anti-reflex cover.
- Antireflex - Schutzfolie abheben.

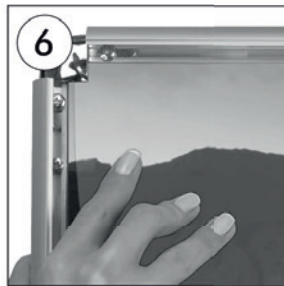

- Place the poster & the cover in.
- Poster einlegen. Antireflex Schutzfolie auf Poster legen und die Seitenprofile in Pfeilrichtung zuklappen.



- Close all profiles.
- Alle Profile in der Pfeilrichtung öffnen.

